



SITESCAPES

P.O. Box 22326
Lincoln, NE 68542

PF: 402/421-9464
FX: 402/421-9479

WEBSITE: www.sitescapesonline.com
E-MAIL: info@sitescapesonline.com

TITLE

*CUSTOM
PICNIC TABLE*

PRODUCT NO.

NY6-2000

INCH TOLERANCES U.O.S.

FRACTION-- $\pm 1/16"$
ANG----- $\pm 1^\circ$

THE INFORMATION CONTAINED IN THIS DRAWING IS THE SOLE PROPERTY OF SITESCAPES, INC. ANY REPRODUCTION IN PART OR AS A WHOLE WITHOUT THE WRITTEN PERMISSION OF SITESCAPES, INC. IS PROHIBITED.

*Available in powder coat and DuraCoat finishes

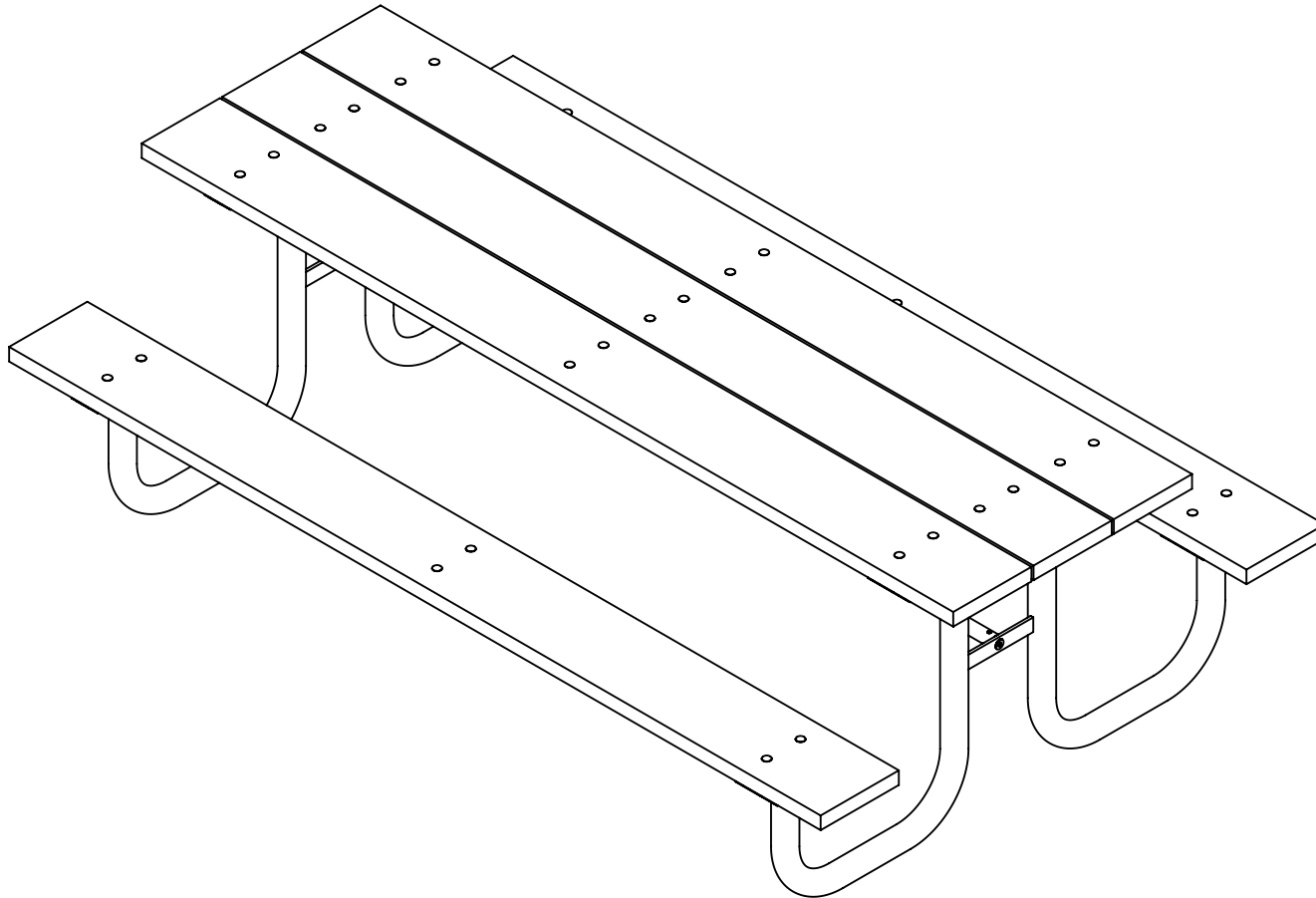



SITESCAPES

P.O. Box 22326
Lincoln, NE 68542

PF: 402/421-9464
FX: 402/421-9479

WEBSITE: www.sitescapesonline.com
E-MAIL: info@sitescapesonline.com

TITLE
**CUSTOM
PICNIC TABLE**

PRODUCT NO.
NY6-2000

FRACTION-- $\pm 1/16"$
ANG----- $\pm 1^\circ$

THE INFORMATION CONTAINED IN THIS DRAWING IS THE SOLE PROPERTY OF SITESCAPES, INC. ANY REPRODUCTION IN PART OR AS A WHOLE WITHOUT THE WRITTEN PERMISSION OF SITESCAPES, INC. IS PROHIBITED.

*Available in powder coat and DuraCoat finishes

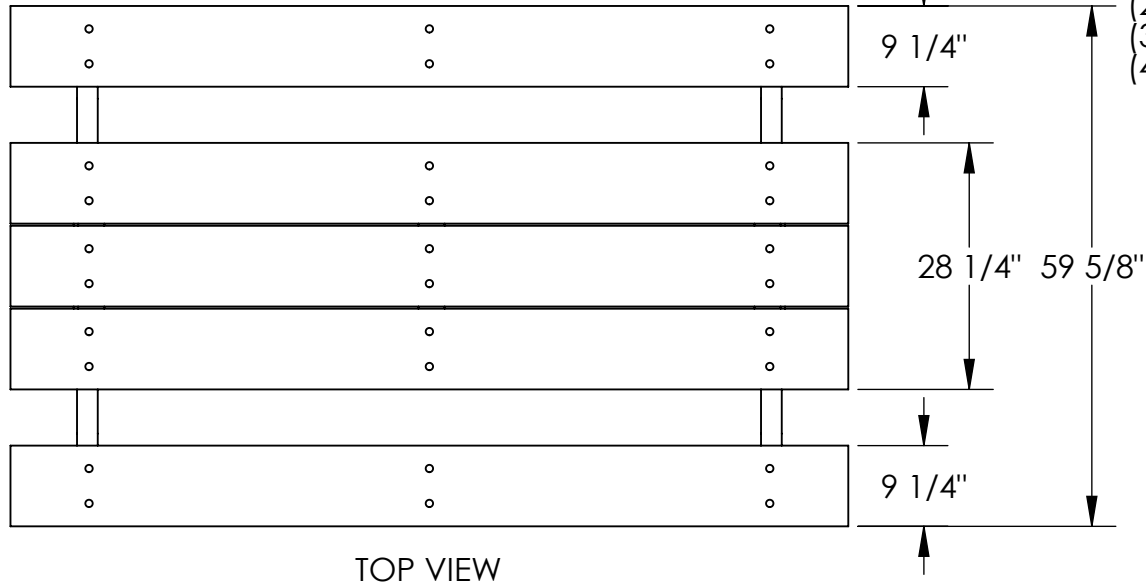

TOP VIEW

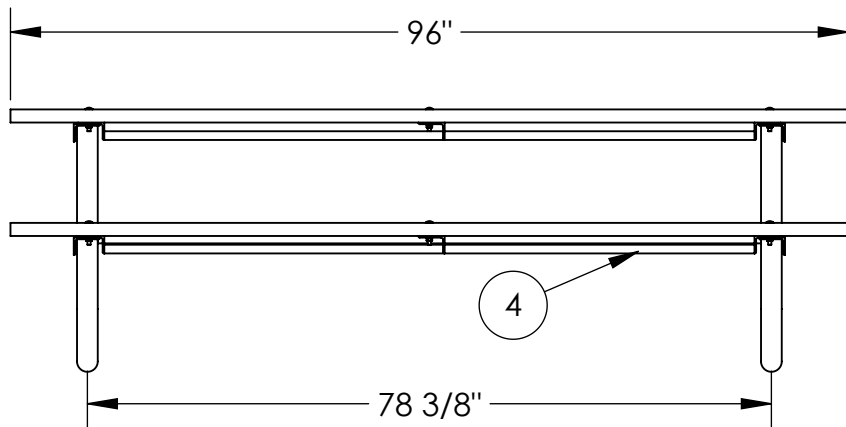

FRONT VIEW

MATERIALS LIST:

- (1) Table/Seat Slats - 2" x 10" Nominal Douglas Fir
- (2) End Unit Tubing - \varnothing 2 3/8" Schedule 40 Steel Pipe
- (3) Support Angles - 2" x 3" x 1/4" Steel Angle
- (4) Support Pipe - \varnothing 1.315" x .133" Steel Pipe

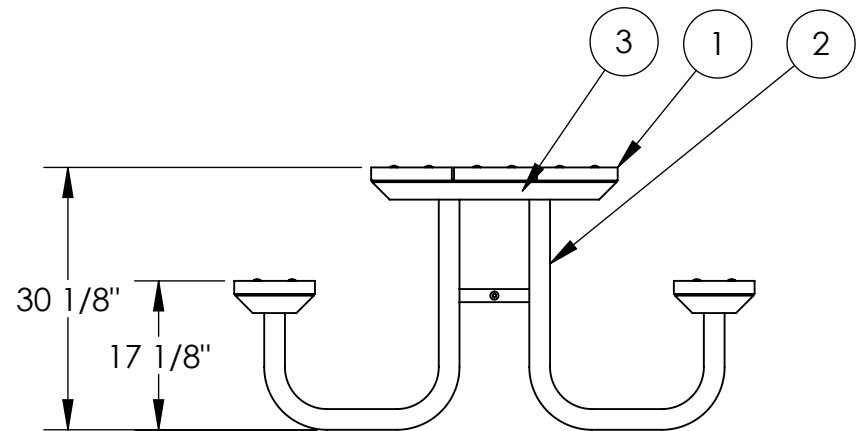
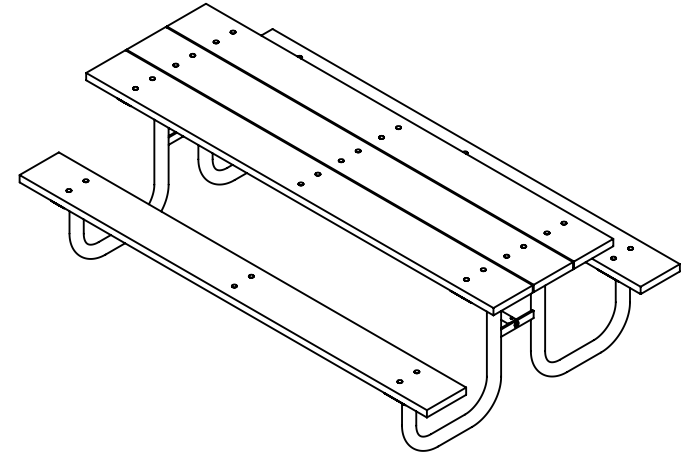

RIGHT SIDE VIEW