



SITESCAPES

P.O. Box 22326  
Lincoln, NE 68542

PF: 402/421-9464  
FX: 402/421-9479

WEBSITE: [www.sitescapesonline.com](http://www.sitescapesonline.com)  
E-MAIL: [info@sitescapesonline.com](mailto:info@sitescapesonline.com)

TITLE

*AVONDALE  
CAROUSEL TABLE*

PRODUCT NO.

*AV6-3334*

INCH TOLERANCES U.O.S.

FRACTION--  $\pm 1/16"$   
ANG-----  $\pm 1^\circ$

THE INFORMATION CONTAINED IN THIS DRAWING IS THE SOLE PROPERTY OF SITESCAPES, INC. ANY REPRODUCTION IN PART OR AS A WHOLE WITHOUT THE WRITTEN PERMISSION OF SITESCAPES, INC. IS PROHIBITED.

\*Available in powder coat and DuraCoat finishes

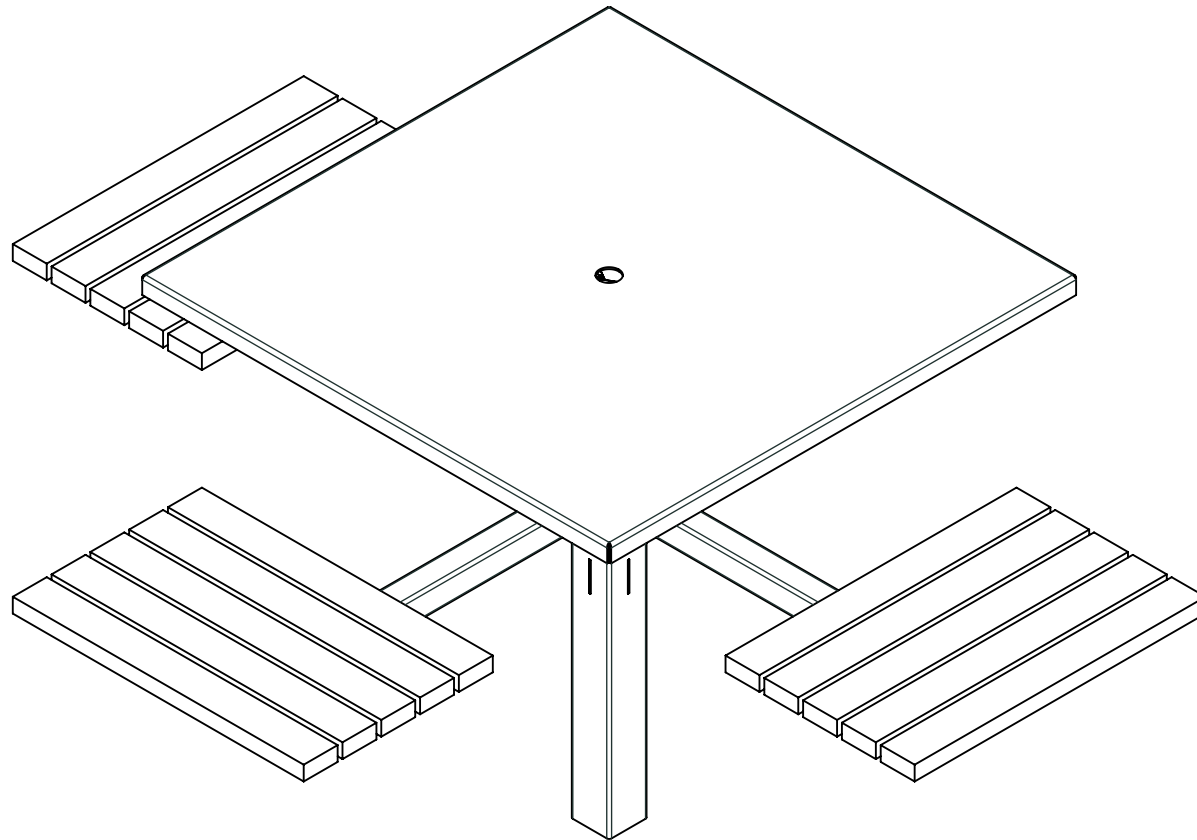



# SITESCAPES

P.O. Box 22326  
Lincoln, NE 68542

PF: 402/421-9464  
FX: 402/421-9479

WEBSITE: [www.sitescapesonline.com](http://www.sitescapesonline.com)  
E-MAIL: [info@sitescapesonline.com](mailto:info@sitescapesonline.com)

TITLE  
**AVONDALE  
CAROUSEL TABLE**

PRODUCT NO.  
**AV6-3334**

FRACTION--  $\pm 1/16"$   
ANG-----  $\pm 1^\circ$

THE INFORMATION CONTAINED IN THIS DRAWING IS THE SOLE PROPERTY OF SITESCAPES, INC. ANY REPRODUCTION IN PART OR AS A WHOLE WITHOUT THE WRITTEN PERMISSION OF SITESCAPES, INC. IS PROHIBITED.

\*Available in powder coat and DuraCoat finishes

### MATERIALS LIST:

- (1) Table Top - 7 Gauge Stainless Steel
- (2) Seat Slats - 2" x 4" Nominal Ipe Wood
- (3) Center Post - 4" x 1/8" Wall Steel Tubing
- (4) Seat Support Tube - 2 1/2" x 1/8" Wall Steel Tubing
- (5) Slat Supports - 1/4" Steel Plate

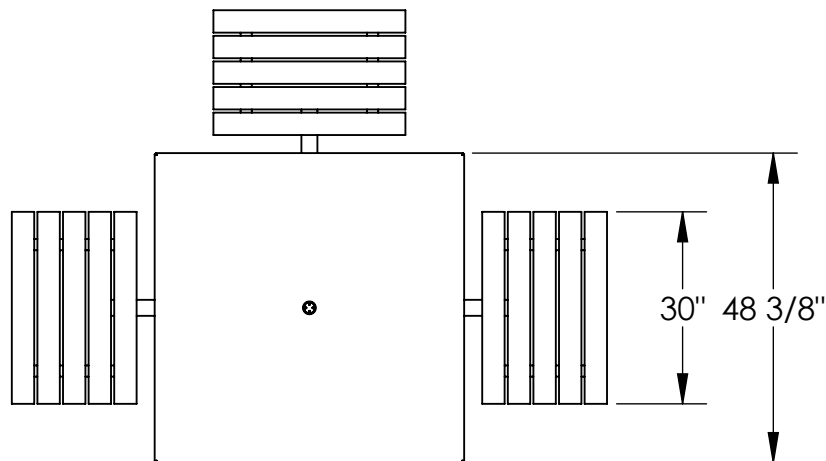

TOP VIEW

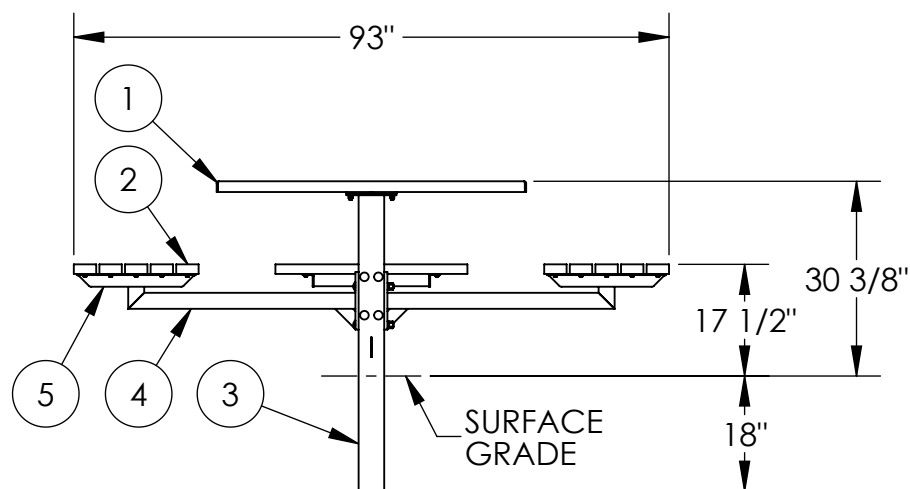
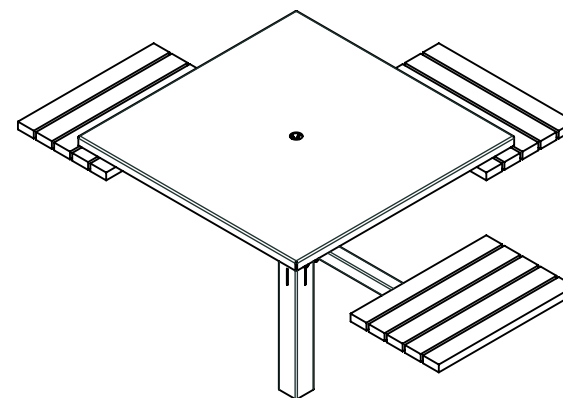

FRONT VIEW

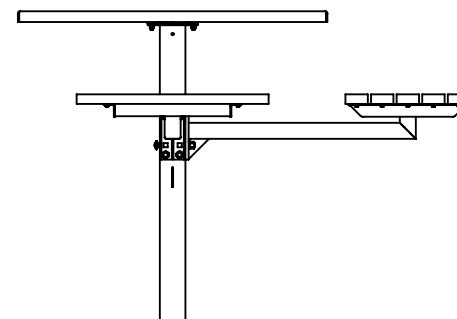

RIGHT SIDE VIEW