



SITESCAPES

P.O. Box 22326
Lincoln, NE 68542

PF: 402/421-9464
FX: 402/421-9479

WEBSITE: www.sitescapesonline.com
E-MAIL: info@sitescapesonline.com

TITLE
*AVONDALE
CAROUSEL TABLE*

PRODUCT NO.
AV6-1140

INCH TOLERANCES U.O.S.
FRACTION-- $\pm 1/16"$
ANG----- $\pm 1^\circ$

THE INFORMATION CONTAINED IN THIS DRAWING IS THE SOLE PROPERTY OF SITESCAPES, INC. ANY REPRODUCTION IN PART OR AS A WHOLE WITHOUT THE WRITTEN PERMISSION OF SITESCAPES, INC. IS PROHIBITED.

*Available in powder coat and DuraCoat finishes

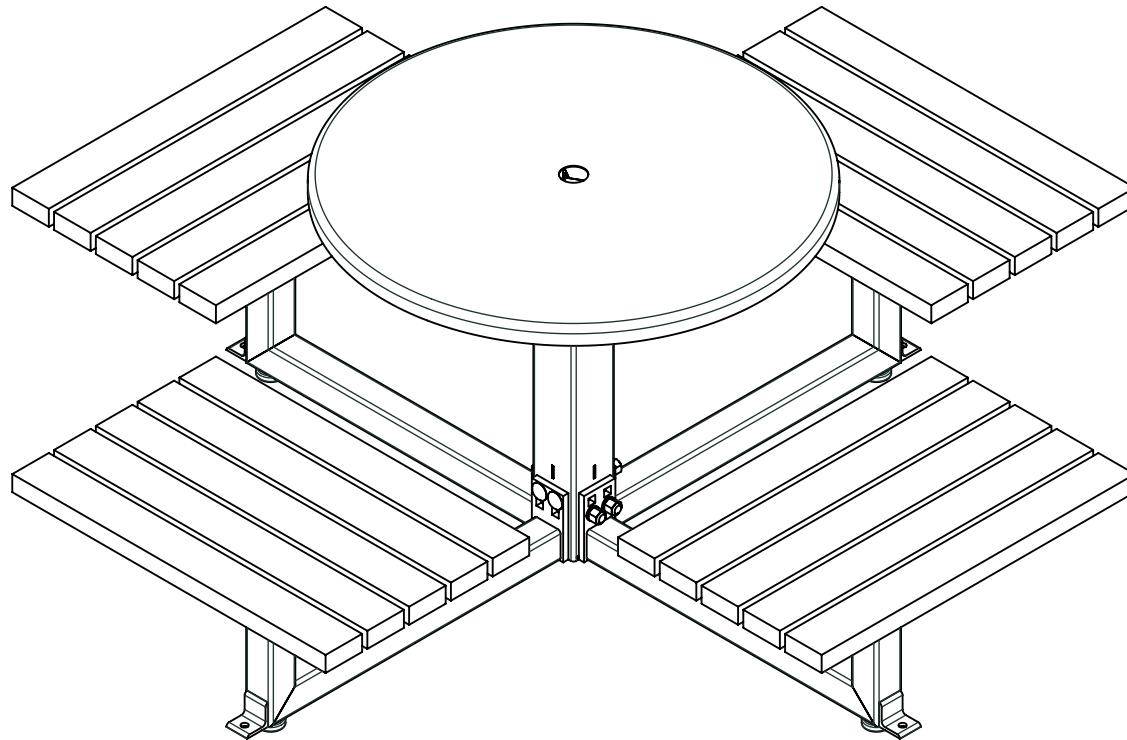



SITESCAPES

P.O. Box 22326
Lincoln, NE 68542

PF: 402/421-9464
FX: 402/421-9479

WEBSITE: www.sitescapesonline.com
E-MAIL: info@sitescapesonline.com

TITLE
**AVONDALE
CAROUSEL TABLE**

PRODUCT NO.
AV6-1140

INCH TOLERANCES U.O.S.
FRACTION-- $\pm 1/16"$
ANG----- $\pm 1^\circ$

THE INFORMATION CONTAINED IN THIS DRAWING IS THE SOLE PROPERTY OF SITESCAPES, INC. ANY REPRODUCTION IN PART OR AS A WHOLE WITHOUT THE WRITTEN PERMISSION OF SITESCAPES, INC. IS PROHIBITED.

*Available in powder coat and DuraCoat finishes

MATERIALS LIST:

- (1) Table Top - 12 Ga. x $\phi 36"$ Stainless Steel
- (2) Center Post - 4" x 1/8" Wall Steel Tubing
- (3) Seat Slats - 2" x 4" Nominal Ipe
- (4) Seat Support Tube - 2 1/2" x 1/8" Wall Steel Tubing
- (5) Slat Supports - 7 Gauge Steel Plate

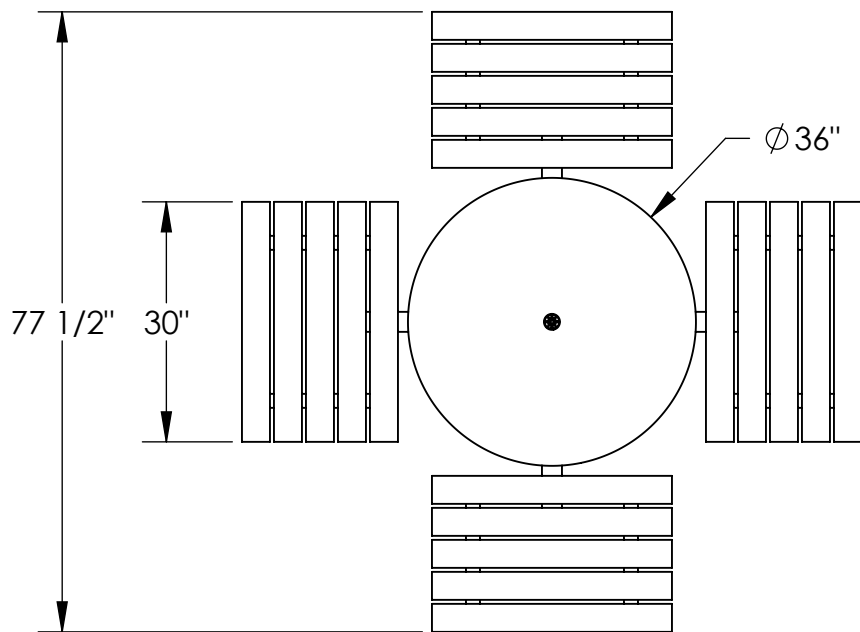

TOP VIEW

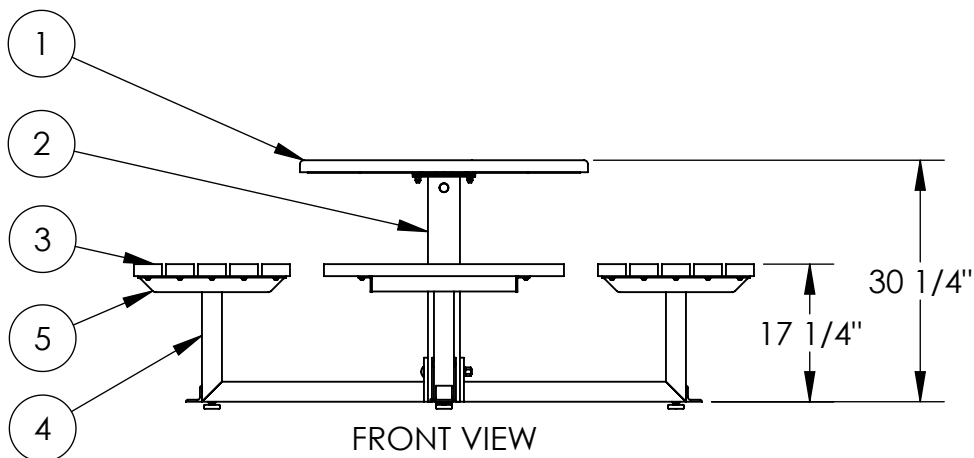
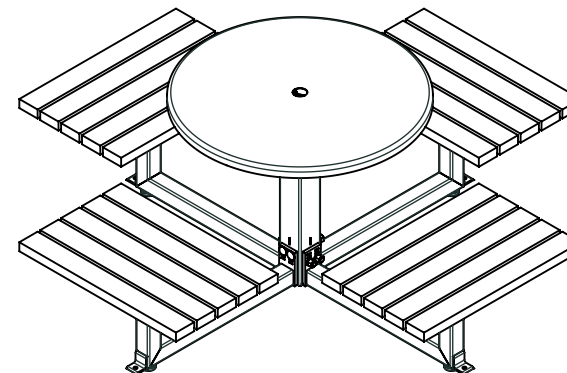

FRONT VIEW

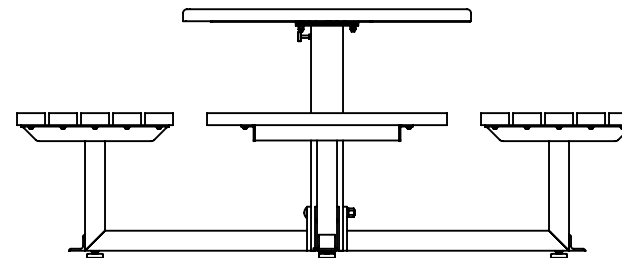

RIGHT SIDE VIEW