



P.O. Box 22326
Lincoln, NE 68542

PF: 402/421-9464 | WEBSITE: www.sitescapesonline.com
FX: 402/421-9479 | E-MAIL: info@sitescapesonline.com

TITLE *CITYVIEW
CAROUSEL TABLE*

PRODUCT NO.
CV6-3220

INCH TOLERANCES U.O.S.
FRACTION-- $\pm 1/16"$
ANG----- $\pm 1^\circ$

THE INFORMATION CONTAINED IN THIS DRAWING IS THE SOLE PROPERTY OF SITESCAPES, INC. ANY REPRODUCTION IN PART OR AS A WHOLE WITHOUT THE WRITTEN PERMISSION OF SITESCAPES, INC. IS PROHIBITED.

*Available in powder coat and DuraCoat finishes

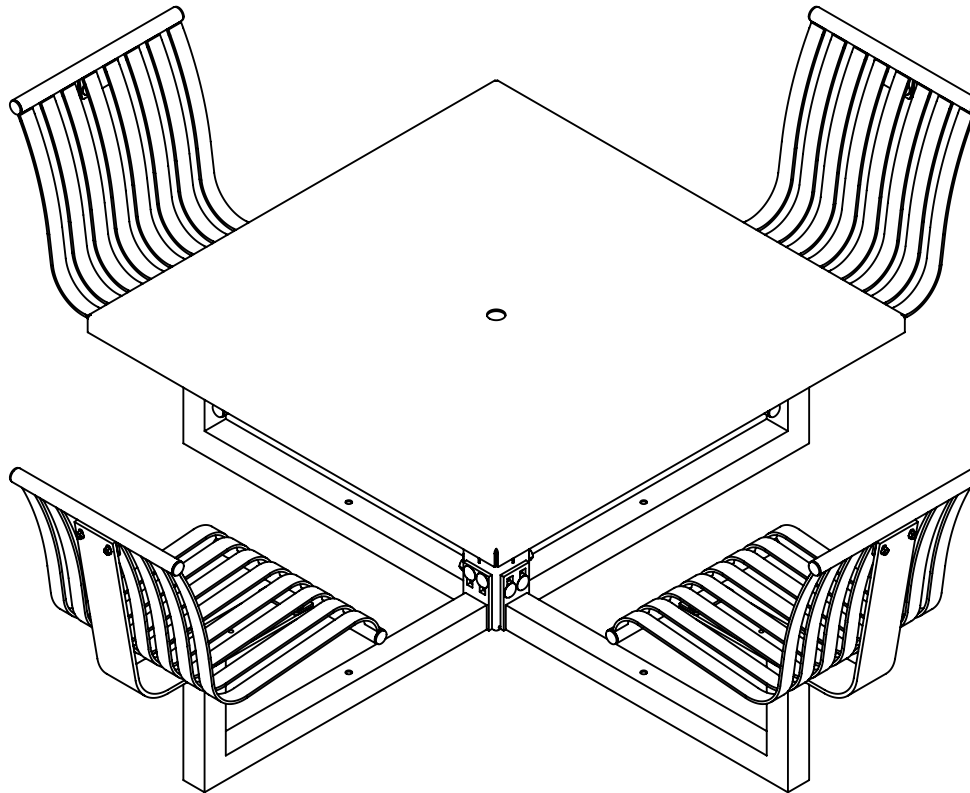



P.O. Box 22326
Lincoln, NE 68542

PF: 402/421-9464 | WEBSITE: www.sitescapesonline.com
FX: 402/421-9479 | E-MAIL: info@sitescapesonline.com

INCH TOLERANCES U.O.S.

FRACTION-- $\pm 1/16"$
ANG----- $\pm 1^\circ$

THE INFORMATION CONTAINED IN THIS DRAWING IS THE SOLE PROPERTY OF SITESCAPES, INC. ANY REPRODUCTION IN PART OR AS A WHOLE WITHOUT THE WRITTEN PERMISSION OF SITESCAPES, INC. IS PROHIBITED.

TITLE *CITYVIEW
CAROUSEL TABLE*

PRODUCT NO.
CV6-3220

*Available in powder coat and DuraCoat finishes

MATERIALS LIST:

- (1) Table Top - 7 Ga. Steel Plate
- (2) Table Top Post - 4" Sq. x 1/8" Wall P&O Steel Tubing
- (3) Chair Support Tubes - 2 1/2" Sq. x 1/8" Wall P&O Steel Tubing
- (4) Chair - 1 1/2" x 1/4" P&O Steel Flat Bar
- (5) 1/2" x 6" Anchor Bolts (Not Shown)

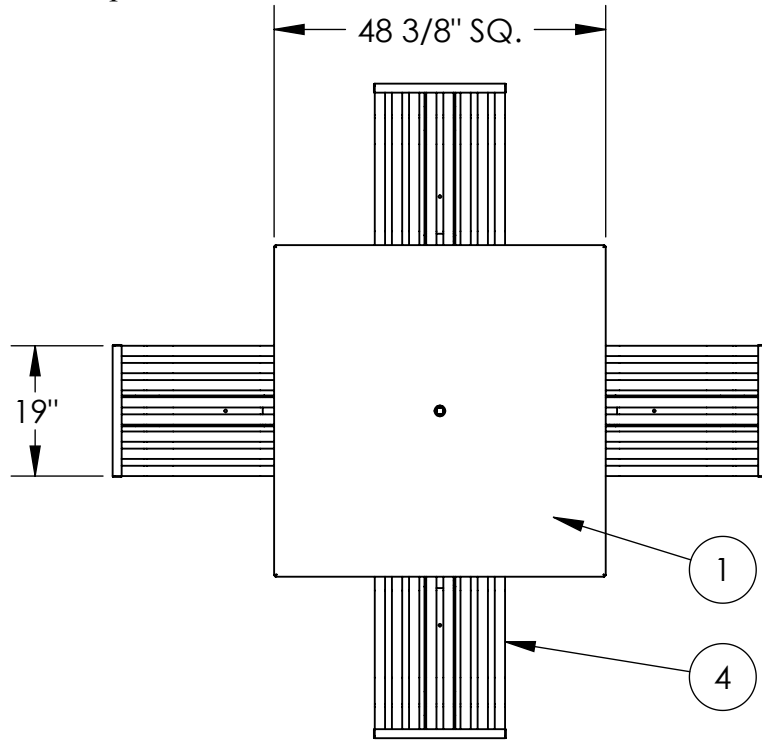

TOP VIEW

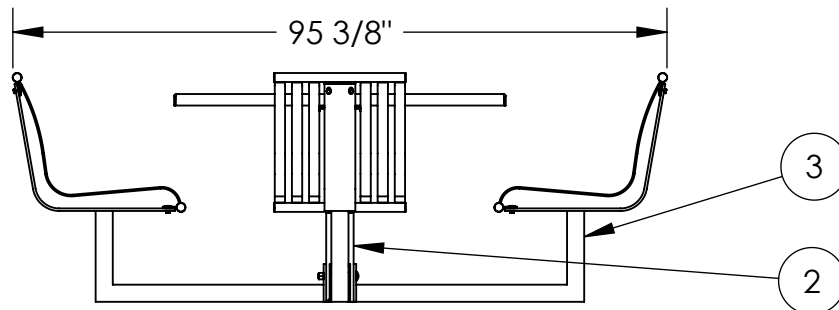
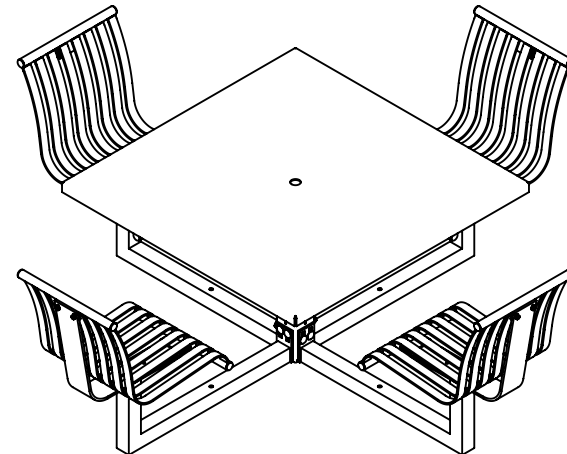

FRONT VIEW

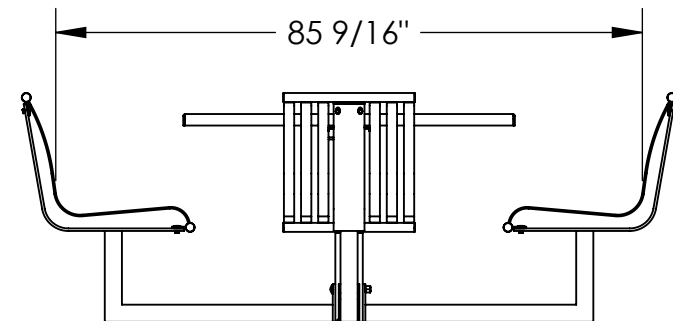

RIGHT SIDE VIEW