



P.O. Box 22326
Lincoln, NE 68542

PF: 402/421-9464 | WEBSITE: www.sitescapesonline.com
FX: 402/421-9479 | E-MAIL: info@sitescapesonline.com

TITLE
*AVONDALE
FLAT BENCH*

PRODUCT NO.
AV1-2110

INCH TOLERANCES U.O.S.

FRACTION-- $\pm 1/16"$
ANG----- $\pm 1^\circ$

THE INFORMATION CONTAINED IN THIS DRAWING IS THE SOLE PROPERTY OF SITESCAPES, INC. ANY REPRODUCTION IN PART OR AS A WHOLE WITHOUT THE WRITTEN PERMISSION OF SITESCAPES, INC. IS PROHIBITED.

*Available in powder coat and DuraCoat finishes

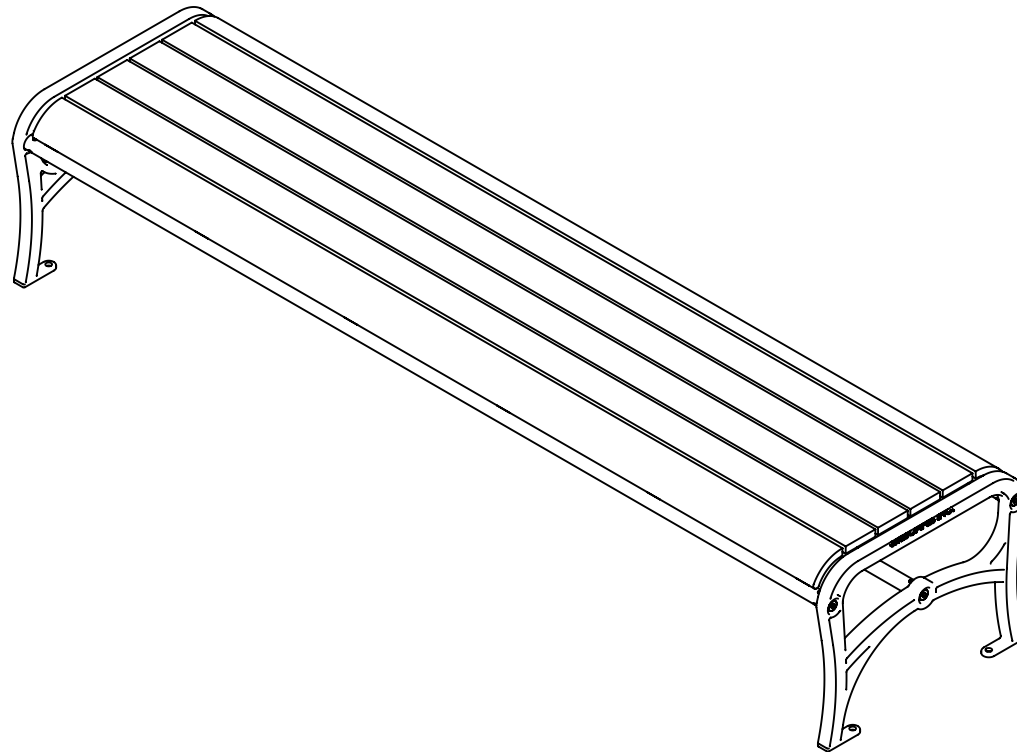



P.O. Box 22326
Lincoln, NE 68542

PF: 402/421-9464
FX: 402/421-9479

WEBSITE: www.sitescapesonline.com
E-MAIL: info@sitescapesonline.com

TITLE
*AVONDALE
FLAT BENCH*

PRODUCT NO.
AV1-2110

INCH TOLERANCES U.O.S.
FRACTION-- $\pm 1/16"$
ANG----- $\pm 1^\circ$

THE INFORMATION CONTAINED IN THIS DRAWING IS THE SOLE PROPERTY OF SITESCAPES, INC. ANY REPRODUCTION IN PART OR AS A WHOLE WITHOUT THE WRITTEN PERMISSION OF SITESCAPES, INC. IS PROHIBITED.

*Available in powder coat and DuraCoat finishes

Materials List

- (1) Seat Straps - Ipe Wood Slats
- (2) Seat Supports - 5/16" x 1 1/2" Steel Flat Bar
- (3) End Units - Cast Iron Unit
- (4) Support Pipes - $\phi 1.315"$ x .133" Steel Pipe
- (5) Mounted with Four $\phi 1/2"$ x 4-5" Stainless Steel Anchor Bolts (Customer Supplied)



TOP VIEW

1

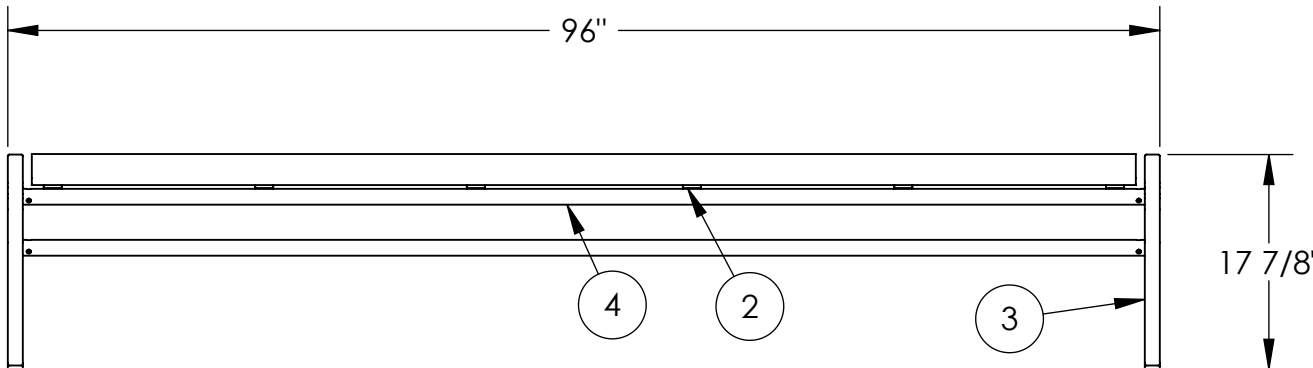
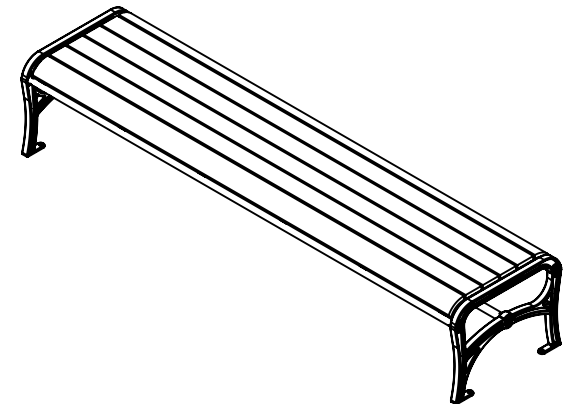

FRONT VIEW

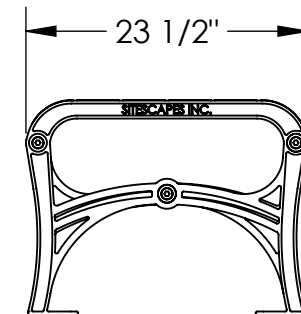

RIGHT SIDE VIEW