



Product Catalog





SiteScapes Site Furnishings

Barristro Collection	3-4
CityView Seating	5-6
CityView Receptacles	7-8
CityView Tables	9
CityView Ash Urns	10
CityView Planters	10
Avondale Seating	11-12
Avondale Receptacles	13
Avondale Tables	14
WestPort Seating	15-16
WestPort Receptacles	17
NewPort Receptacles	18
Arlington Seating	19-20
TallGrass Seating	21
TallGrass Receptacles	22
Stadium Collection Tables	23-24
JordanCreek Seating	25
JordanCreek Receptacles	26
Meridian Seating	27
Meridian Receptacles	28
PublicMetro Seating	29
Cambridge Receptacles	30
Echo Bike Parking	31
Apex Bike Parking	32
Classic Bike Parking	32
Bike Post Bollards	33
Smoking Post Bollards	33
Terra Firma Tree Grates	34
Custom Projects	35
Special Use Lids	35
Custom Plaques/Signage	36
Sustainability Information	37
Finishes	38
Warranty	38

SiteScapes Site Furnishings

SiteScapes is a manufacturer dedicated to providing a comprehensive line of durable, steel site furnishings. SiteScapes products offer unlimited design flexibility for design and landscape professionals, while providing quick and easy installation for contractors, maintenance crews, or municipal personnel. Products include benches, trash receptacles, planters, bike racks, tables, tree grates and guards and more.

SiteScapes Projects Include:

BC Parks and Rec - Vancouver, BC	Med Center of the Rockies - Loveland, CO
City of Rockwall - Rockwall, TX	Providence Market Place - Mount Juliet, TN
City of Savannah - Savannah, GA	Puerto Rico National Cemetary - Bayamon, PR
City of Seattle - Seattle, WA	Ty Cobb Regional Medical Center - Lavonia, GA
Children's Mercy - Independence, MO	Treasure Island Beach, Clearwater, FL
Creighton University - Omaha, NE	University of Maryland- Baltimore, MD
East Tennessee State - Johnson City, TN	UNMC - Omaha, NE
Jet Blue Park - Fort Meyers, FL	USC - Los Angeles, CA
John Deere - Moline, IL	Waverly Place Mall - Cary, NC
Many, Many More	

For Pricing

Contact SiteScapes Inc. or a manufactures representative.

Prices and specifications are subject to change. All prices F.O.B. factory. All shipping weights include crate enclosures and are estimates that may vary. Payment terms are 2% Prox 10 with prior credit approval.

SiteScapes products are made in the USA

© SiteScapes Inc. All Rights Reserved.
Printed in USA.

The image shows three modern, colorful plastic chairs arranged in a row on a concrete patio. The chairs are red, green, and black. They have a curved, ergonomic design with a small square cutout on the backrest. The background features a wall of horizontal wooden planks on the left and a large glass window on the right. The window reflects the surrounding environment, including trees and a building. The text 'Barristro Seating' and 'Café/Patio Seating' is overlaid on the window area.

Barristro Seating
Café/Patio Seating

Barristro Café/Patio Seating & Bike Parking

Designed by Justin Brouillette, the Barristro collection was proposed as a small family of like minded urban furnishings with an array of uses and users in mind. The collection's fluid geometry allows for modular pieces to interact in interesting and unique ways.



Materials

Seating Area - 1/4" Steel plate
Interior Tubes - 2" x 2" square tube
Foot plates - 1/4" stainless steel

To Specify Barristro Seats

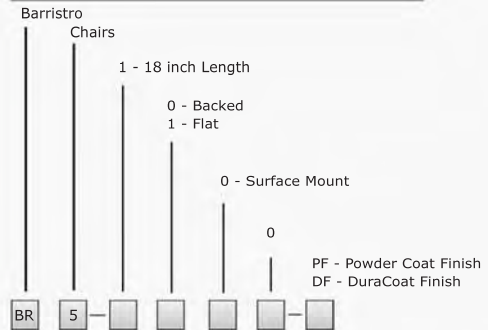

To Specify Barristro Parking

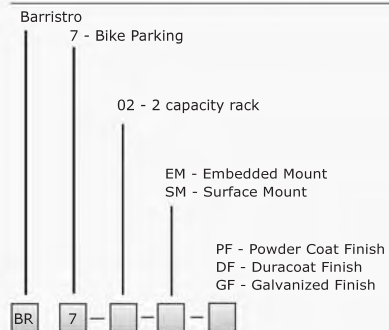

Backed Seat



Backless Seat



CityView Vertical Strap Seating

A popular vertical strap design, the CityView bench is suited for many urban seating solutions. In addition to requiring no assembly, this bench remains maintenance free.



Materials

Seat straps – 5/16" x 1 1/2" steel flat bar
Support pipe - 1" dia. schedule 40 steel tubing
End units - 1" square solid steel bar
Foot plates - 1/4" x 1 1/2" stainless steel

Choices

Choose six or eight foot length; backed, arched back or backless bench; steel bar ends, cast iron ends, steel radius loop ends, or steel bar ends no armrests; zero or one center armrest; powdercoat or Duracoat finish; and color.



To Specify CityView Benches

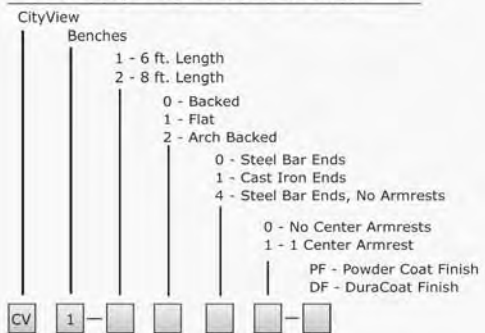

Steel Bar Ends



Cast Iron Ends



No Armrests



Steel Radius Ends



Flat Steel Bar Ends



Flat Cast Iron Ends



Arch Back

The image shows two black, cylindrical trash containers with vertical straps. The larger container is in the background, and a smaller one is in the foreground. Both have a domed top and a flared rim. They are set on a concrete pad next to some dry grass and a paved area. The background is a blurred outdoor scene with trees and a fence.

CityView Receptacles
Vertical Strap Trash Containers

CityView Vertical Strap Receptacles

The CityView receptacles are durable trash containers with style. These receptacles bring balance to any urban setting while providing capacity for essential everyday refuse concerns.



Choices

Choose 40 gallon, 36 gallon, or 32 gallon capacity; top opening, side door with latch or side door with key; surface, surface pedestal or embedded pedestal mount; flat, dome, ash or enclosed top; powdercoat or Duracoat finish; and color.

Materials

Vertical straps - 5/16" x 1 1/2" steel flat bar
 Outside support strap - 1/4" x 2" steel flat bar
 Top ring - 5/8" dia. solid steel round bar
 Foot plates - 1/4" x 1 1/2" stainless steel
 Lid - 14 ga. spun steel lid
 Dome - 12 ga. spun steel dome
 Ash inlay - 13 ga. stainless steel ash pan
 Liner - High Density Polyethylene liner with handles



To Specify CityView Receptacles

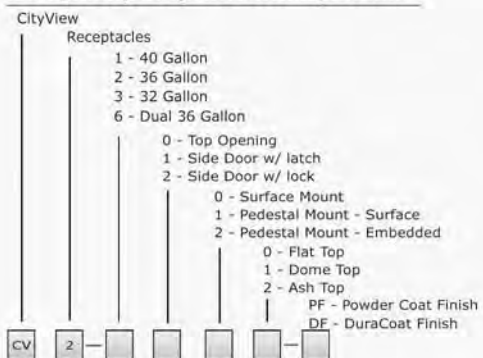

* Side Door receptacles available in 36 gallon capacity only.
 * Pedestal mount receptacles available in 30 gallon capacity only.
 * Side Door not available in pedestal mount.



Flat Top

Dome Top

Ash Top

Enclosed Top

CityView Vertical Strap Tables & Chairs

CityView tables utilize signature CityView collection vertical straps in a multitude of options and configurations. Stainless steel table tops provide maximum durability. Tables are offered in free standing, carousel, and picnic styles and require minimal assembly.



Materials

CityView Table materials vary greatly with build and configuration. Please refer to product specifications for product specific details.

Choices

Choose table dimension; round, square, ribbon style or rectangular table top, number of seats, freestanding, surface, or embedded mount; powdercoat or Duracoat finish; and color.

To Specify CityView Tables

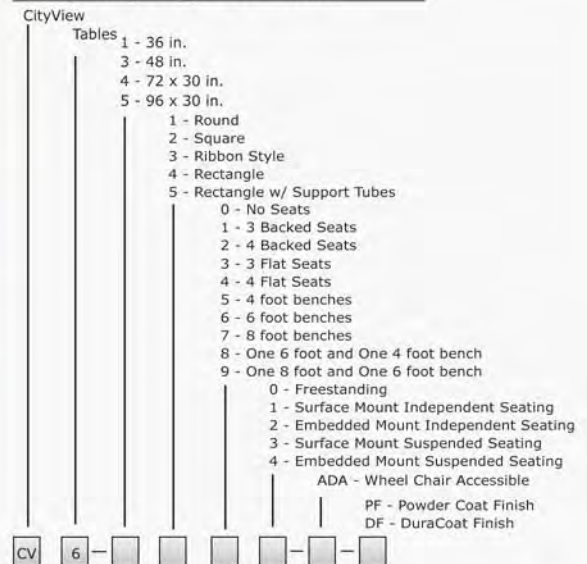



CityView Vertical Strap Ash Urns

CityView Ash Urns

These stand alone ash urns can be utilized in multiple environments and complete the CityView collection. The flair top urns include a stainless steel ash pan for cigarette collection and keep trash containers ash free. This product will surface mount to any concrete pad and has a removable ash tray for easy cleaning.

Materials

1/4" straps for maximum durability
Removable stainless steel 8" o.d. ash pan for ash collection

CityView Ash Urns are currently offered in only one style. CV3-1000 to specify.



CityView Vertical Strap Planters

CityView Planters

Planters provide color and life to otherwise inorganic settings. Twenty-two gallon liners provide potting volume suitable for a large variety of plantings.

Materials

5/16" straps for maximum durability
Removable stainless steel 8" o.d. ash pan for ash collection

CityView Planters are currently offered in only one style. CV4-1000 to specify.



Avondale Seating
Wood/Plastic Seating

Avondale Wood Slat Seating

Avondale benches utilize Ipe hardwood seating. This Brazilian hardwood weathers to a smooth and attractive finish while remaining extremely resistant to decay and insects. Recycled plastic can be substituted for wood on any Avondale product.

Materials:

Seat straps - 1"x4" Ipe hardwood or recycled plastic
 Support pipe - 1" dia. schedule 40 steel tubing
 End units - 1" square solid steel bar
 Foot plates - 1/4" x 1 1/2" stainless steel
 No visible hardware on seating or back rest surfaces

Choices

Choose six or eight foot length; backed or backless; steel bar ends, cast iron ends, steel radius loop ends, or steel bar ends with no armrests; zero or one center armrest, powdercoat or Duracoat finish; and color.

Standard Plastic Colors available:

Cherry Wood, Cedar, Weathered Wood, Sand, Woodland Green, Black, Slate Gray, Light Gray, and White.



Premiere Plastic Colors available:

Brown, Redwood, Rust Brown, and Light Oak.



To Specify Avondale Benches

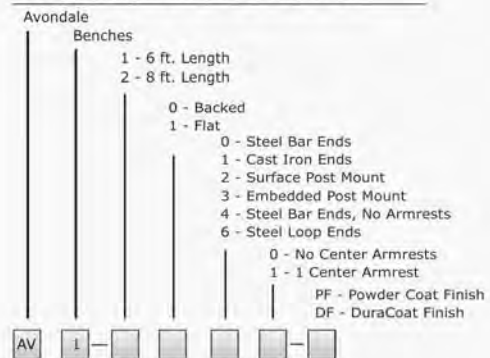

Avondale Wood Slat Receptacles

The Avondale receptacles are durable trash containers with style made of wood or recycled plastic. Avondale receptacles will promote a green, litter free environment.



Choices

Choose surface, surface-pedestal or embedded pedestal mount; flat, dome, ash or enclosed top; powdercoat or Duracoat finish; and color.

Materials

2" x 4" Recycled Plastic or Wood Slats
 Interior Support Ring - 7 ga. Steel
 Mounting Plates - 1/4" x 1/2" Stainless Steel
 Lid - 28" o.d. Spun Steel Lid
 Liner - High Density Polyethylene

To Specify Avondale Receptacles

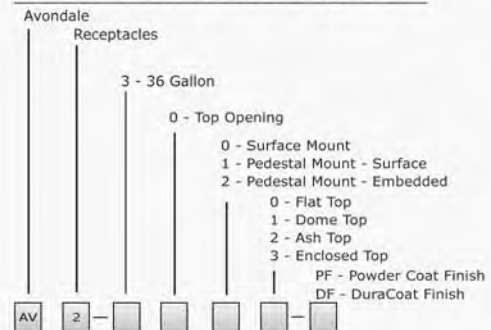

Flat Top



Dome Top



Ash Top



Enclosed Top

Avondale Wood Slat Picnic Tables

Avondale wood and recycled plastic picnic tables provide traditional group sitting options with bench seating perfect for parks and natural settings.



Materials

Avondale Table materials vary greatly with build and configuration. Pleaser refer to product specifications for product specific details.

Choices

Choose table dimension; round, square, ribbon style or rectangular table top, number of seats, freestanding, surface, or embedded mount; Ipe Hardwood or recycled plastic; powdercoat or Duracoat finish; and color.

To Specify Avondale Tables

Avondale

Tables

- 1 - 36 in.
- 3 - 48 in.
- 4 - 72 x 30 in.
- 5 - 96 x 30 in.

- 1 - Round
- 2 - Square
- 3 - Ribbon Style
- 4 - Rectangle
- 5 - Rectangle w/ Support Tubes

- 0 - No Seats
- 1 - 3 Backed Seats
- 2 - 4 Backed Seats
- 3 - 3 Flat Seats
- 4 - 4 Flat Seats
- 5 - 4 foot benches
- 6 - 6 foot benches
- 7 - 8 foot benches
- 8 - One 6 foot and One 4 foot bench
- 9 - One 8 foot and One 6 foot bench

- 0 - Freestanding
- 1 - Surface Mount Independent Seating
- 2 - Embedded Mount Independent Seating
- 3 - Surface Mount Suspended Seating
- 4 - Embedded Mount Suspended Seating

ADA - Wheel Chair Accessible

PF - Powder Coat Finish
DF - DuraCoat Finish

AV 6 - [] - [] - [] - [] - [] - [] - []





WestPort Seating
Horizontal Strap Seating

WestPort Horizontal Strap Seating

The WestPort bench utilizes horizontal seat straps. Each 1/4" seat strap is supported and held firmly in place by a series of braces. Such engineering provides a durable and aesthetically pleasing product in all aspects.



Materials

Seat straps – 1/4" x 1 1/2" steel flat bar
Support pipe - 1" dia. schedule 40 steel tubing
End units - 1" square solid steel bar
Foot plates - 1/4" x 1 1/2" stainless steel

Choices

Choose six or eight foot length; backed or backless; steel bar ends, cast iron ends, steel radius loop ends, or steel bar ends no armrests; zero or one center armrest; powdercoat or Duracoat finish; and color.



To Specify WestPort Benches

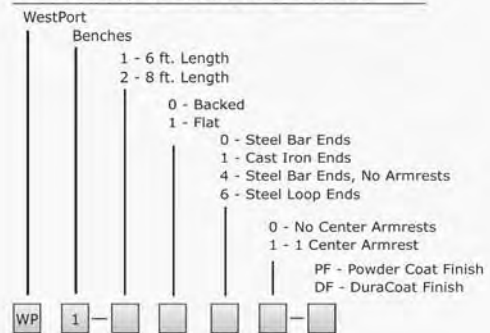

Steel Bar Ends



Cast Iron Ends



No Armrests



Steel Loop Ends



Flat Steel Bar Ends



Flat Cast Iron Ends

WestPort Horizontal Strap Receptacles

The WestPort receptacle's unique shape and style set it apart from other receptacles. The WestPort is surrounded by a durable solid square bar framework and makes use of horizontal steel straps.



Materials

Horizontal straps - 1/4" x 1" steel flat bar
 Support Strap - 5/16" x 3/4" steel flat bar
 Top Support - 1" dia. schedule 40 steel tubing
 Bottom Support Bars - 5/16" x 3/4" steel flat bar
 Side Support Bars - 1" sq. steel flat bar
 Lid - .083 wall steel lid
 Surface Mount Plates - 5/16" x 1 1/2" stainless steel
 Liner - High Density Polyethylene liner with handles

Choices

Choose top opening or side door with lock; flat, dome or ash top; powdercoat or Duracoat finish; and color.



To Specify WestPort Receptacles

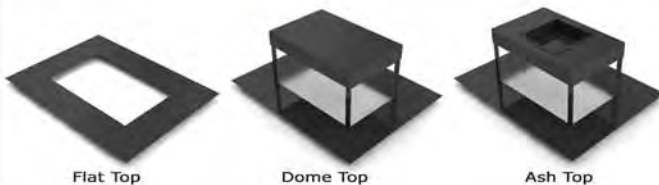
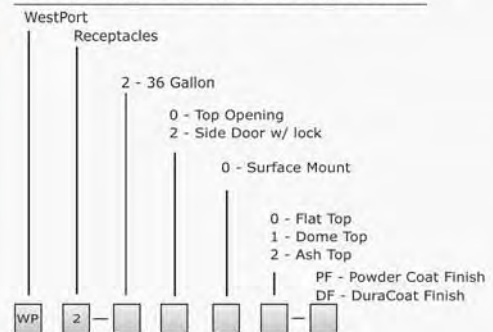

Newport Vertical Strap Receptacles

The Newport receptacle is a top opening, high volume trash receptacle designed for high traffic areas. The Newport receptacle design incorporates vertical straps and square steel bar supports into the can for a unique style.



Materials

- Container – 7 ga. steel sheet
- Top Ring - 1 1/2" Tubing
- Support Bars - 1" Square Steel Bar
- Surface Mount plates - 1/4" x 1 1/2" stainless steel plate
- Lid - 14 ga. spun steel lid
- Dome - 12 ga. spun steel dome
- Ash inlay - 13 ga. stainless steel ash pan
- Liner - High Density Polyethylene liner with handles

Choices

Choose 40 gallon or 36 gallon capacity; flat, dome, ash or enclosed top; powdercoat or Duracoat finish; and color.



To Specify Newport Receptacles

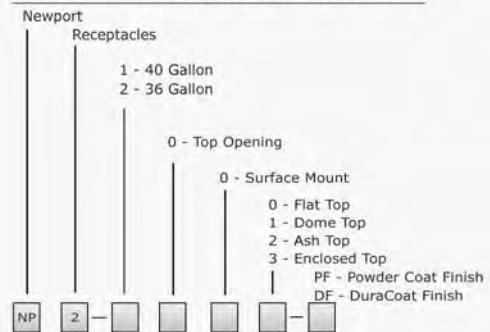

Flat Top



Dome Top



Ash Top



Enclosed Top



Arlington Seating
Filigree Cast Iron Seating

Arlington Filigree Cast Iron Seating

Arlington benches feature a beautiful decorative cast iron end with ornamental filigree and looping symmetry. This classic Victorian bench is perfect for historic and traditional projects.



Materials

Seat straps – 1/4" x 1 1/2" steel flat bar; or
2" x 3" Nominal Ipe or recycled plastic
Support straps - 3/8" Flat Bar
Support Pipes - 1" dia. schedule 40 steel tubing
End units - 1" Cast iron with 9/16" mounting holes

Choices

Choose six or eight foot length; Ipe hardwood, recycled plastic, vertical strap, or horizontal strap; zero or one center armrest; powdercoat or Duracoat finish; and color.

To Specify Arlington Benches

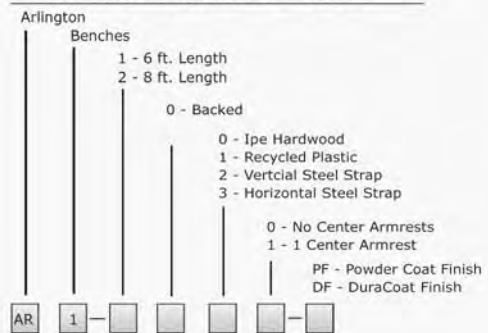

Ipe Wood Slats



Recycled Plastic



Vertical Strap



Horizontal Strap

TallGrass TallGrass Pattern Seating

A variation of the JordanCreek, TallGrass seating utilizes a square tubing frame and accentuates its natural surroundings, while blending into a variety of urban settings.

Materials

Frame - 1 1/2" Sq. x 11 Ga. Wall Steel Tubing
 Panels - 7 Ga. Steel Sheet Metal
 Foot Plates - 1/4" x 1 1/2" Stainless Steel with 9/16" Mounting Holes

Choices

Choose six or eight foot length; backed or backless bench; zero or one center armrest; powdercoat or Duracoat finish; and color.



To Specify TallGrass Benches

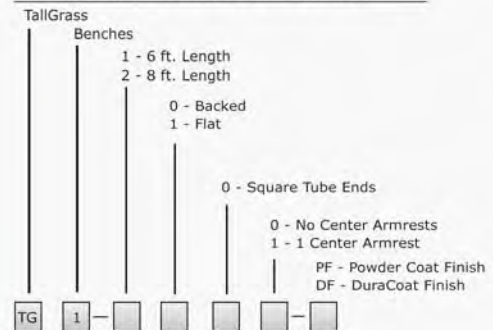

Backed Bench Backless Bench

TallGrass TallGrass Pattern Receptacles

The TallGrass receptacle utilizes the TallGrass pattern and is built in many variations, including a compact efficient receptacle, a square receptacle, and a large round body receptacle.



Materials

Small Round

Container - 7 ga. Steel Shell
Removable Dome Lid

36 Gallon Square

Frame - 1 1/2" Sq. x 11 Ga. Wall Steel Tubing
Panels - 7 Ga. Steel Sheet Metal
Foot Plates - 1/4" x 1 1/2" Stainless Steel

36 Gallon Round

Container - 7 Ga. Steel Shell
Support Bars - 1" x 3/4" Steel Flat Bar
Lid - 24" x .075" Wall Steel Lid

Choices

Choose 40 gallon or 36 gallon capacity; flat, dome, ash or enclosed top; powdercoat or Duracoat finish; and color.

To Specify TallGrass Receptacles

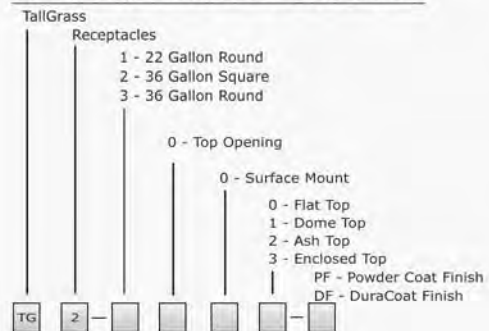

* Flat top not offered in 22 Gallon capacity

** Enclosed top offered in 36 Gallon round only.



Flat Top



Dome Top



Ash Top



Enclosed Top

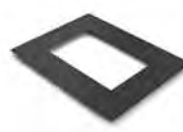

Flat Top

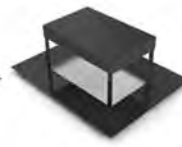

Dome Top



Ash Top

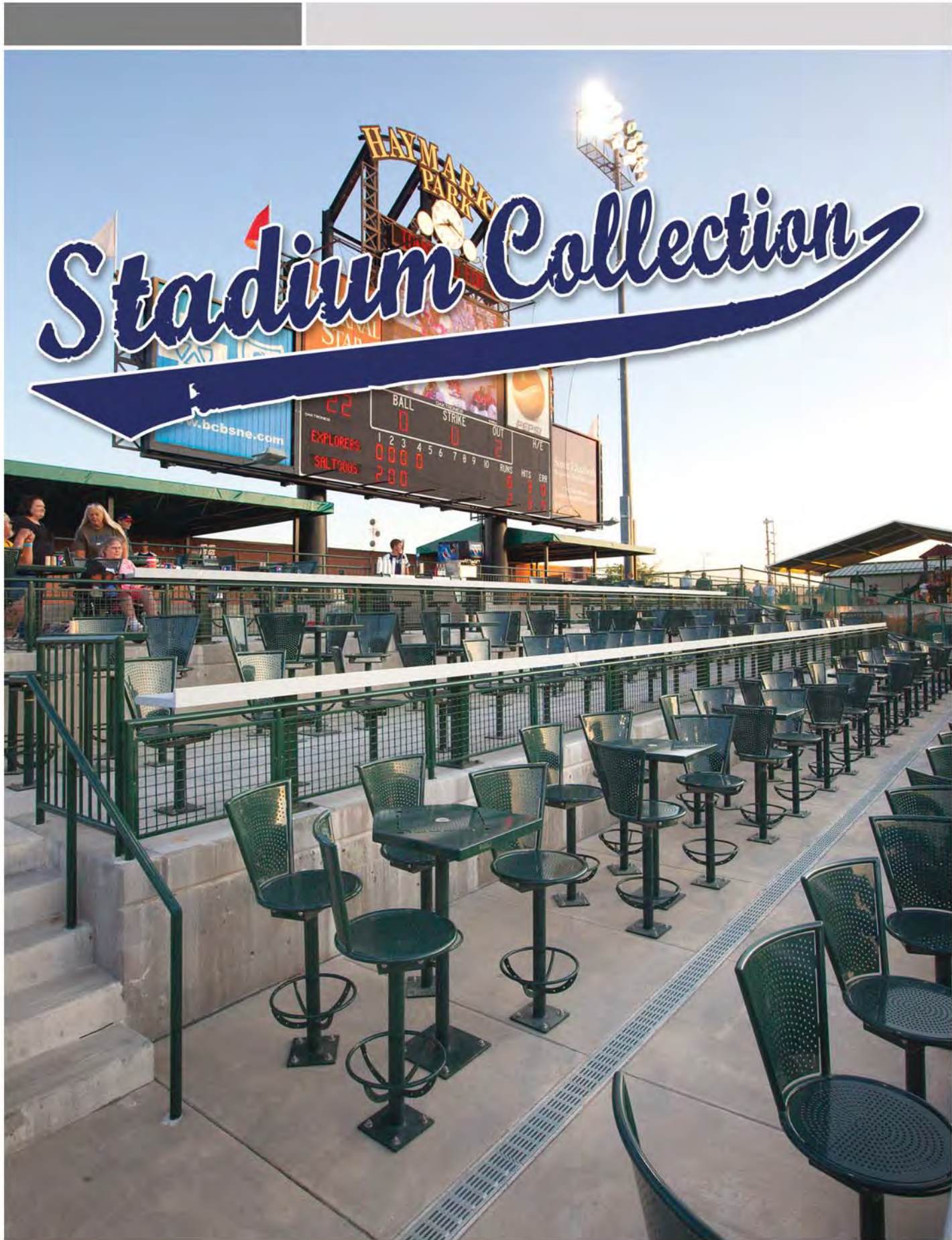

Stadium Collection Custom Pattern Tables

Enjoy the action of the game in comfort with the SiteScapes Stadium Collection. Available in bar height or dining height, this baseball themed collection can incorporate team or sponsor logos and is perfect for any sports venue.

The Stadium Collection table is made with corrosion resistant stainless steel and is available with a 24" round or home plate shaped table top. Each aluminum chair features its own 90 degree brass in-line swivel.



Materials

- Table Top - 10 ga. Stainless Steel
- Table Support - 2 3/8" o.d. Steel Tube
- Chair Frame - 7/8" Aluminum Tube
- Seat Panel/Back Rest - 10 ga. Perforated Aluminum
- Chair Support - 2 3/8" o.d. Steel Tube
- Base Plates - 8" Square 3/8" Thick Stainless Steel Plate
- Foot Rests - 5/8" Solid Steel Rod

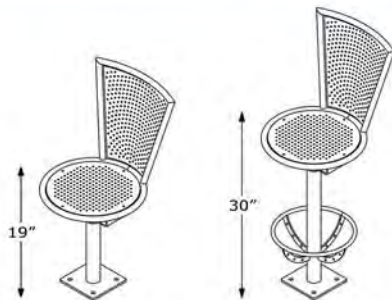

Height Options

Stadium Collection Tables and Chairs are offered in two heights: dining and bar height. Dining height chairs are perfect for cafe style areas and provide a seat height of 19". Bar height chairs sit 30" tall and are better suited for elevated view seating or tiered seating.

Wall Mount

Stadium Collection Tables are also offered in a wall mount. Use a wall mount for standing room only areas or in places where a traditional pedestal mount simply won't do. Wall mounted tables are secured using 1/2" o.d. concrete wedge anchors for maximum stability.

To Specify Stadium Tables

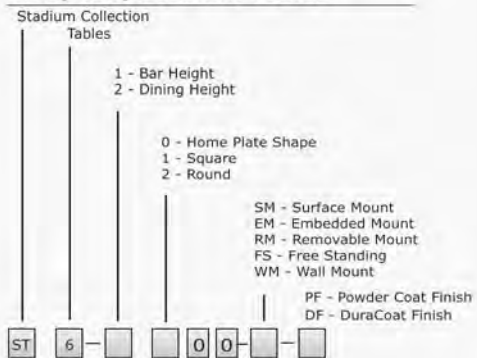

To Specify Stadium Chairs

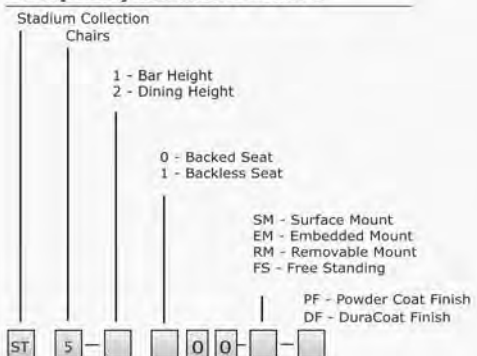

JordanCreek JordanCreek Pattern Seating

JordanCreek benches match square tubing with elegant laser cut curvature. Bench patterns are laser-cut and can be customized to include neighborhood logos or simple graphics.



Materials

Frame - 1 1/2" Sq. x 11 Ga. Wall Steel Tubing

Panels - 7 Ga. Steel Sheet Metal

Foot Plates - 1/4" x 1 1/2" Stainless Steel with 9/16" Mounting Holes

Choices

Choose six or eight foot length; backed or backless bench; zero or one center armrest; powdercoat or Duracoat finish; and color.

To Specify JordanCreek Benches

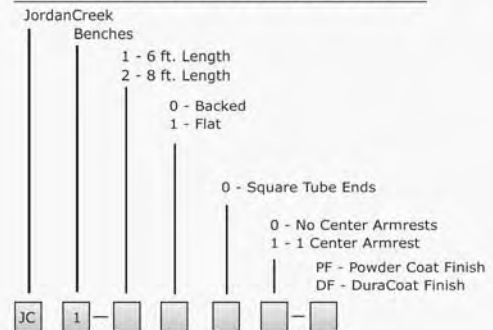

Backed Bench



Backless Bench

JordanCreek JordanCreek Pattern Receptacles

This receptacle is constructed of steel tubing and contains a decorative inset in each side panel that matches the rest of the collection. JordanCreek panels are laser cut and are completely customizable.



Materials

Frame - 1 1/2" Sq. x 11 Ga. Wall Steel Tubing

Panels - 7 Ga. Steel Sheet Metal

Foot Plates - 1/4" x 1 1/2" Stainless Steel with 9/16" Mounting Holes

Choices

Choose flat, dome or ash top lid; powdercoat or Duracoat finish; and color.



To Specify JordanCreek Receptacles

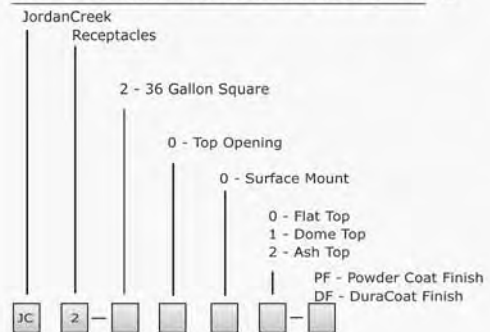

Flat Top



Dome Top



Ash Top

Meridian Metal Rod Seating

The Meridian bench utilizes rigid horizontal metal rods to form its seating surface. Delivered as a fully assembled unit, this robust bench bolts directly to a concrete pad for permanent installation.



Materials

Metal Rods - 5/8" o.d. solid
 End units - 1" solid square bar, heavy-wall square tubing, or cast iron
 Support Pipe - 1" dia. schedule 40 steel tubing
 Foot plates - 1/4" x 1 1/2" stainless steel

Choices

Choose six or eight foot length; backed or backless; steel bar ends, cast iron ends, steel radius loop ends, or steel bar ends with no armrests; zero or one center armrest; powdercoat or Duracoat finish; and color.

To Specify Meridian Benches

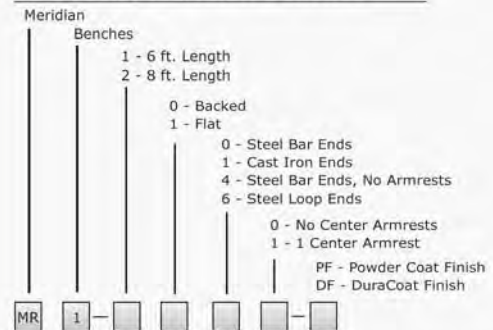

Steel Bar Ends



Cast Iron Ends



No Rests



Steel Loop Ends



Flat Steel Bar Ends



Flat Cast Iron Ends

Meridian Metal Rod Receptacles

Utilizing a rigid metal rod construction, these receptacles are as exquisite as they are sturdy. This receptacle provides a high volume litter container that stands up to any environment.



Materials

- Metal rods - 5/8" o.d. solid
- Top Ring - 3/4" steel round bar
- Support Ring - 1/4" steel plate
- Support Bars - 1/2" x 1" steel flat bar
- Foot Plates - 1/4" x 1 1/2" stainless steel
- Lid - 14 ga. spun steel lid
- Dome - 12 ga. spun steel dome
- Ash Inlay - 13 ga. stainless steel ash pan

Choices

Choose 40 or 32 gallon capacity; flat, dome, ash, or enclosed top; powdercoat or Duracoat finish; and color.

To Specify Meridian Receptacles

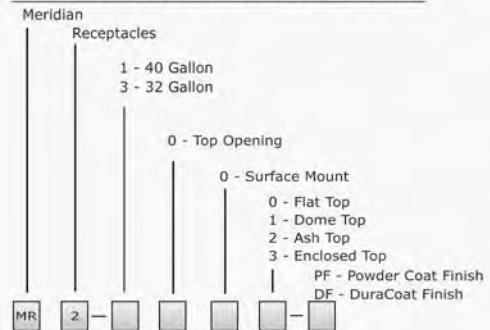

Flat Top



Dome Top



Ash Top



Enclosed Top

Public Metro Modular Seating

The PublicMetro is a modular seating design suitable for a variety of public settings. Each tubular seat is individually mounted to the heavy duty base and is available in straight or custom curved configurations.

Materials

Seat Panels - 1/8" punched aluminum
 Seat Frames - 7/8" dia. x .095 wall aluminum tubing
 Support Legs - 2" dia. x 1/8" wall steel tubing
 Support Pipe - 3" o.d. steel tubing
 Surface Plates - 7 1/2" dia. x 1/4" thick stainless steel plate

Choices

Choose six or eight foot length; backed or backless; wire mesh or perforated steel; powdercoat or Duracoat finish; and color.



To Specify Public Metro Seating

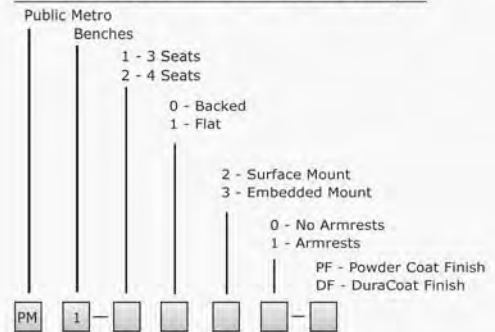

Backed Seating



Backless Seating



Custom Radius Option

Cambridge Space Efficient Receptacles

This space efficient receptacle embodies style and elegance, while maintaining a durable steel shell. The compact dimensions of this product allows it to exist in settings where space is of the essence.



Materials

Container - 7 Gauge Steel Shell
Dome - 18" x .105" Wall Steel Dome

Choices

Choose dome top or ash top; stainless steel, powdercoat or Duracoat finish; and color.

*Cambridge receptacles can be customized to include labels, logos or graphics for special use.

To Specify Cambridge Receptacles

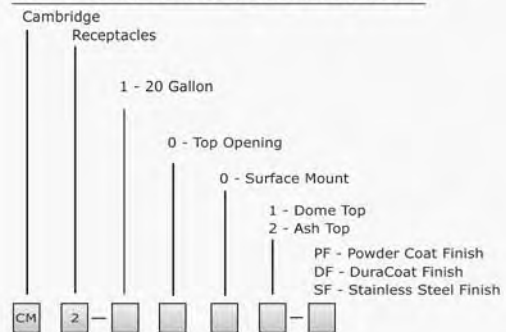

Dome Top



Ash Top

Echo Serpentine Bike Parking

These popular serpentine style racks are rugged and space efficient. Allowing for parking from both sides of the rack, the echo can be embedded mount or surface flange mount.



Materials

Tubing - 2 3/8" dia. schedule 40 steel tubing
Foot Plates - 7 1/2" dia. x 1/4" stainless steel

Choices

Choose five, seven, nine, eleven or thirteen capacity; embedded or surface mount; powdercoat, Duracoat, galvanized or stainless steel finish; and color.

Embedded Mount has both legs placed in core drilled holes 10" below surface grade. The holes are then filled with concrete to secure the bike rack

Surface Mount has a surface plate on both legs. When the bike rack is positioned it is secured with stainless steel anchor bolts. (customer supplied)

To Specify Echo Bike Parking

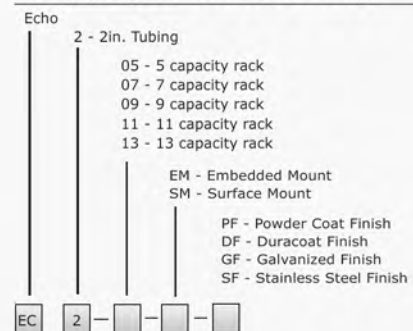



Apex Single Loop Bike Parking

This "inverted U" style rack can be installed to form any configuration you desire. These racks are a durable, space saving solution for all of your bike security needs.

Materials

Tubing - 2 3/8" dia. schedule 40 steel tubing

Foot Plates - 7 1/2" dia. x 1/4" stainless steel

Choices

Choose two, six or ten capacity; embedded or surface mount; powdercoat, Duracoat, galvanized or stainless steel finish; and color.



Classic Grid Style Bike Parking

Classic bike racks provide traditional grid style bike parking for large numbers of bikers. These economical bike racks are available in single or double sided parking options.

Materials

End Units - 1 1/2" o.d. x 13 gauge steel tubing

Horizontal Support Tubes - 1 1/4" o.d. x 13 ga. steel tubing

Vertical Separation Bars - 5/8" o.d. solid steel bar

Surface Plates - 3/8" stainless steel plate

Choices

Choose single or double sided parking, and surface or embed mounting options. Available finishes include powder coat, Duracoat, Galvanized or stainless steel.



Bike Post **Bollard Style** Bike Parking

This space efficient product can serve the dual purpose of barrier and bicycle security. Various loop configurations are available. Bike Posts can be embed or surface mount.

Materials

Posts - 4 1/2inch o.d. Steel Tubing
Loops - 1" Steel Tubing
Surface Plate - 7 1/2" o.d. steel

Choices

Choose zero, one or two loops; embedded or surface mount; powdercoat or Duracoat; and color.



Smoking Post **Bollard Style** Cigarette Receptacle

Smoking Post Bollards give your designated smoking areas a clean, professional look. Bollards are fashioned to keep entrances or smoking areas clean and litter-free while using an unobtrusive design.

Materials

Posts - 4 1/2inch o.d. Steel Tubing
Surface Plate - 7 1/2" o.d. steel

Choices

Choose surface or embedded mount; powder coat or Duracoat; and color.

TerraFirma Starburst Pattern Tree Grates

These ADA approved cast iron tree grates allow for trees to co-exist with pedestrians in a variety of settings. TerraFirma grates have a starburst pattern and are available in a multitude of sizes and shapes.



The TerraFirma tree grates can have custom lettering and logos inserted at an additional cost.

Tree Grate Frame

Steel angle frames used to position and mount the tree grate are available for both new and existing concrete.

Materials

Tree Grate - 3/4" cast iron grate
Frame - 1/4" steel angle

Tree Grates are available in starburst and concentric circle patterns.

Choices

Choose round or square; 36, 48 or 60 inch diameter or length; raw or powdercoat finish; and color.

To Specify TerraFirma Tree Grates

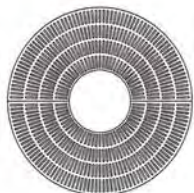
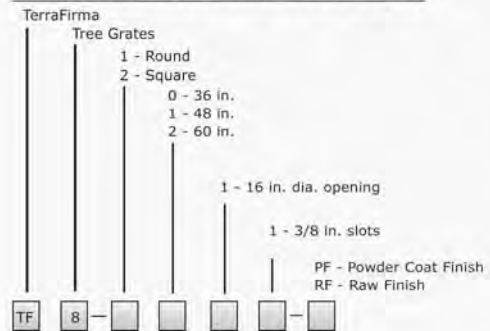

The round TerraFirma tree grates are available in sizes of:

- 36" dia. (TF8-1011)
- 48" dia. (TF8-1111)
- 60" dia. (TF8-1211)

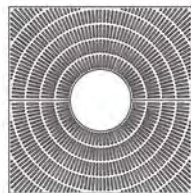

The square TerraFirma tree grates are available in sizes of:

- 36" sq. (TF8-2011)
- 48" sq. (TF8-2111)
- 60" sq. (TF8-2211)

Custom Fabrication Project Specific Product

SiteScapes welcomes the opportunity to work on custom projects. Our custom products include the same great quality and attention to detail as our standard offerings and may be exactly what your site is looking for.

We enjoy utilizing our capabilities and knowledge of materials to meet the challenge of bringing a conceptual product to life.



Special Use Lids Recycling and Custom Lids

In addition to standard trash receptacle lids, SiteScapes specialty lids can convert a standard receptacle into a recycling unit that will match your purpose.

Specialty use lids can be used to sort paper, plastic, aluminum, glass, and trash and come in a variety of shapes and sizes. Receptacles include split interior liners when applicable for sorting. Options are limitless and can be customized for your needs.

For more information check out:
www.sitescapesonline.com/lid-option.asp

Pictured top-left is the custom art project "Golden Rod". SiteScapes worked with DLR Group and Vanessa Schutte to create this art installation seating piece for Omaha's "Take a Seat" project. As part of an art/function mission, this project allowed us to showcase our capabilities while participating in a local creative outlet for the community.

Pictured at left, is a CityView carousel table with Lincoln, Nebraska neighborhood association, Fallbrook's, custom logo in the chair back. This seating utilizes a high contrast backing plate to give the seats a personality all their own.



Custom Plaques Logos and Engraved Signage

SiteScapes custom plaques and vinyl decals allow you to provide a dedication, logo or user instruction for your site furnishings. Our plaques are cast aluminum with a matching powder coat finish to combine durability and beautiful presentation perfect for any memorial or logo.



Custom logos and graphics can be worked into SiteScapes products to give your project its own unique identity. From plaques and decals to laser cut lettering and emblems our custom capabilities allow for endless possibilities.

Signage and decals are a great and cost effective way to engage community interaction and sponsorship of your project. Memorial plaques allow individuals, groups and organizations to honor and recognize loved ones.

For more information check out:
www.sitescapesonline.com/memorial-plaque-option.asp

Sustainability

LEED and Environmental Information

SiteScapes thoroughly recognizes the critical importance of utilizing recycled materials in their benches and receptacles and embraces the opportunity to take part in the "Green Building" movement.

STEEL: SiteScapes, Inc. purchases its steel materials from steel mills that primarily utilize Electric Arc Furnace (EAF) technology. The EAF technology makes use of post-consumer scrap steel by melting it down for reuse in new steel materials.

SiteScapes, Inc. products are manufactured of primarily steel flat bar, steel solid square bar and steel sheet materials. As you can see from the below data, our mill vendors report excellent levels of recycled content in each of these materials allowing SiteScapes, Inc. to provide environmentally friendly steel products for use in "Green Building" applications or LEED programs.

Product Recycled Content
Steel Bar Products 99%
Steel Sheet Products 70%

DUCTILE CAST - Bench Ends: SiteScapes, Inc. ductile cast iron bench ends are poured with 60% post-consumer materials and 40% nodular pig iron. In addition, a small percentage of the make up of the nodular pig iron (iron ore, coke and limestone) is also post-consumer resources.

GRAY CAST - Tree Grates: All tree grate base materials are 100% post-consumer materials. These materials are derived from the melting of shredded auto bodies, scrap steel, used engine blocks etc. No pig iron is utilized in this production process.

WOOD: SiteScapes, Inc. purchases its wood materials from IBAMA (Brazilian Institute for the Environment and the Renewal of Natural Resources) registered mills. All wood is certified to provide the product origin and compliance with all legal log harvesting policies. In addition, these mills participate in "Fields to Forests" reforestation programs. As a result, a tropical tree is replanted in a certified plantation program for every 500 board feet of lumber supplied.

RECYCLED PLASTIC: High Density Polyethylene (HDPE) is the only product used as the raw material base in the production of these items. No other products such as, wood pulp, wood fiber, or fiberglass is used. 60% of all items used on our products derive from post consumer (recycled) or post industrial (scrap) materials.

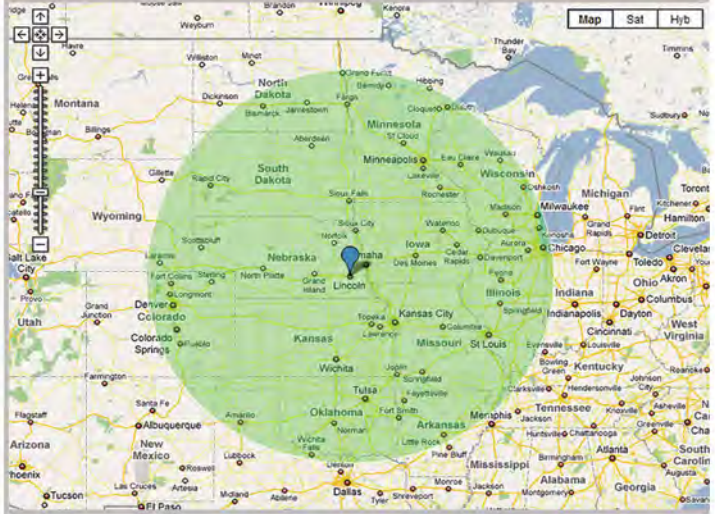

As part of the Materials and Resource credits, LEED offers points for products that are extracted and manufactured locally. LEED has defined locally as a 500 mile radius from the project's location. Because SiteScapes is located in Lincoln, NE we can provide site furnishings to a large section of the midwest that meet this criteria.

Other possible points include: SS 4.2 Bike Storage, SS 5.2 Open Space, MR Prerequisite Collection of Recyclables, MR 4.1 Recycled Content 10%, MR 4.2 Recycled Content 20%, and MR 7.0 Certified wood.

For more information check out:
www.sitescapesonline.com/sustainability.asp



Standard Powder Options



Recycled Plastic Options

Standard Colors available: Cherry Wood, Cedar, Weathered Wood, Sand, Woodland Green, Black, Slate Gray, Light Gray, and White.



Premiere Colors available: Brown, Redwood, Rust Brown, and Light Oak.



Colors shown are only a representation of standard colors offered and should not be used as a substitute for manufacturer provided paint chips.

Finishes & Warranty

Finishes:

SiteScapes, Inc. has a firm understanding that a quality powder coat finish is an essential ingredient to our site furnishings. That is why we offer two varieties of exterior rated, polyester, powder coat finishes for all of our products.

Powder Coat Finish: This protocol of cleansing, sealing, and coating is a 10 step process that provides each product with an extremely corrosion resistant polyester finish in your choice of color. This finish allows each product to remain impervious to rusting, fading, or cracking. The powder coat finish remains virtually maintenance free and is accompanied by a one year warranty.

Duracoat Finish: This finish incorporates all of the processes implemented in the powder coat finish including shot blast, phosphatizing, and pre-treatment. However, Duracoat finished products receive a zinc rich epoxy undercoat that is applied prior to the TGIC polyester top coat of color. This provides a corrosion resistant layer to seal all welded joints and surfaces. The end result is an extremely durable and abrasion resistant coating that is accompanied by a five year warranty. Duracoat finish is highly recommended for high salt content environments.

Colors available: Onyx (Black) Cobalt (Dark Blue) Forest (Green) Brandywine (Burgundy) Ivory (Ivory) Silver (Silver) Slate (Dark Gray) Bronze (Brown) Pearl (White) * custom colors available upon request.

Limited Warranties:

Limited twenty year warranty against structural failure of steel bench frames or steel bench assemblies, table frames, trash receptacle frames and planter frames. SiteScapes, Inc. liability and the buyer's remedy under these warranties are limited to the repair, replacement or refund of the purchase price, at SiteScapes option, of products determined in SiteScapes reasonable judgment to be defective in workmanship or materials. SiteScapes will not be held responsible for the costs incurred in labor to remove, install, or replace the alleged defective product. SiteScapes warranties do not cover any defects or failures resulting from vandalism, negligence, accidents, abuse, lack of maintenance, improper use or installation, or unapproved modifications and repairs. In addition, SiteScapes will not be held liable for ANY damage or injury as a result of product that is not permanently anchored in place or not anchored properly.



P.O. Box 22326 Lincoln NE 68542
p. 888.331.9464 f. 402.421.9479
www.SiteScapesOnline.com
info@sitescapesonline.com

PRESORT
STANDARD
US POSTAGE
PAID
LINCOLN, NE
PERMIT 422



30% POST CONSUMER CONTENT

